



STENNER

Metering Pumps
Manufactured Since 1957

PCM Series

Pump Control Module

INSTALLATION AND
MAINTENANCE MANUAL

Table of Contents

- Warranty and Service Policy 3
- Safety Information 4-5
- Specifications 6
- PCM and Pump Sizing 7-11
- Installation 12-13
- Troubleshooting 14
- PCM Model Conversion 15

Warranty and Service Policy

Damaged or Lost Shipments

UPS and prepaid truck shipments: Check your order immediately upon arrival. All damage must be noted on the delivery receipt. Call Stenner Customer Service at 800-683-2378 for all shortages and damages within seven (7) days of receipt.

Returns

Stenner offers a 30-day return policy. Except as otherwise provided, no material will be accepted for return after 30 days from purchase. To return merchandise at any time, call Stenner at 800-683-2378 for a Returned Goods Authorization (RGA) number. A 15% re-stocking fee will be applied. Include a copy of your invoice or packing slip with your return.

Limited Warranty

Stenner Pump Company will for a period of one (1) year from the date of purchase (proof of purchase required) repair or replace – at our option – all defective parts. Stenner Pump Company is not responsible for any removal or installation costs. Stenner Pump Company will incur shipping costs for warranty products shipped from our factory in Jacksonville, Florida. Any tampering with major components, chemical damage, faulty wiring, weather conditions, power surges, or products not used with reasonable care and maintained in accordance with the instructions will void the warranty. Stenner Pump Company limits its liability solely to the cost of the original product. We make no other warranty expressed or implied.

Disclaimer

The information contained in this manual is not intended for specific application purposes. Stenner Pump Company reserves the right to make changes to prices, products, and specifications at any time without prior notice.

Safety Information

 **WARNING** Warns about hazards that **CAN** cause death, serious personal injury, or property damage if ignored.

 **ELECTRIC SHOCK HAZARD**

 **WARNING** **ELECTRIC SHOCK HAZARD:**
Equipment is supplied with grounding power cord and attached plug. To reduce risk of electrical shock, connect only to a properly grounded, grounding type receptacle.

 **DO NOT** alter the power cord or plug end.

 **DO NOT** use receptacle adapters.

 **DO NOT** use PCM with a damaged or altered power cord or plug. Contact the factory for repair.



 **WARNING** **HAZARDOUS VOLTAGE:**
DISCONNECT power cord before removing motor cover for service.
Electrical service by trained personnel only.

 **WARNING** **EXPLOSION HAZARD:**
This equipment **IS NOT** explosion proof. **DO NOT** install or operate in an explosive environment.

 **WARNING** **RISK OF FIRE HAZARD:**
DO NOT install or operate on any flammable surface.

Safety Information continued

 **NOTICE:** Indicates special instructions or general mandatory action.

-  **DO NOT** attempt installation or service prior to reading and understanding all safety hazards. This equipment is designed for installation and service by trained personnel.
-  **DO** install PCM so that it is in compliance with all national and local codes.
-  **DO** use all required personal protective equipment when working on or near chemical metering pumps.

 This is the safety alert symbol. When displayed in this manual or on the equipment, look for one of the following signal words alerting you to the potential for personal injury or property damage.

 **PCM INTENDED FOR INDOOR USE.**

 Electrical installation should adhere to all national and local codes. Consult a licensed professional for assistance with proper electrical installation.

Specifications

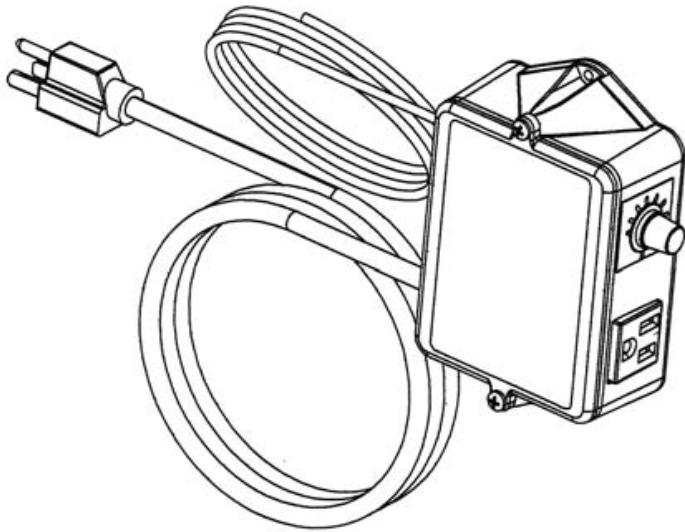

Timer Microcontroller with triac output
 Turndown Ratio 10:1
 Housing Polycarbonate plastic
 Shipping Weight 2 lbs

Input Signal Non-voltage dry contact, water meter
 Reset Time Immediate
 Minimum Signal Duration 10 milliseconds

Input Electrical 120V 60Hz
 No Load Current 0.45mA AC maximum

Output Electrical maximum device load, 1.8 amp at 120V

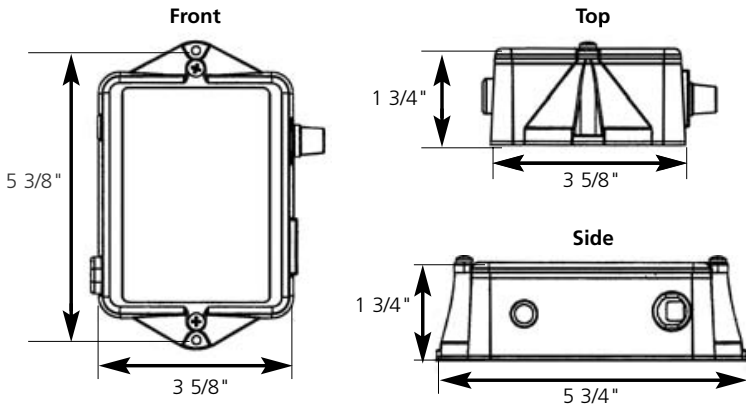

PCM and Pump Sizing

Pre-sizing Requirements

- Maximum flow rate (of the water system) in gallons per minute (gpm)
- Required dose amount in parts per million (ppm)
- Solution strength in parts per million (ppm)
- Water meter contacts per gallon (cpg or ppg)
- Stenner fixed output metering pump

Water Meter cpg/ppg (partial list)

Meter Size	Max Flow Rate (gpm)	Meter cpg/ppg
3/4"	20	10
3/4"	20	5
3/4"	20	2.5
3/4"	20	1
1"	50	1
1"	50	2
1"	50	4
1"	50	5
1 1/2"	100	1
1 1/2"	100	2
1 1/2"	100	4

The most popular water meter and the easiest for calculation purposes is the 1 contact (cpg) or 1 pulse per gallon (ppg) dry contact water meter.

Key

cpg	contacts per gallon (ppg pulse per gallon)
ppm	parts per million
gpm	gallons per minute
gpd	gallons per day
gps	gallons per second
spg	seconds per gallon

US and Canada call 1-800-683-2378, other countries call 1-904-641-1666

PCM and Pump Sizing continued

I. Determining Available Dose Time

1. The available dose time is the minimum time interval (seconds) between the water meter contact closures during the maximum system flow rate. Each closure sends an input signal to the PCM.

 **Do not adjust the PCM time to a longer duration than the minimum time duration between water meter contacts.**

2. The available dose time is calculated using two equations:
 - a. Divide 60 seconds by the maximum system flow rate in gpm to convert to seconds per gallon.

$$60 \text{ seconds} \div \text{gpm} = \text{spg}$$

- b. Divide the seconds per gallon by the water meter's contacts per gallon to determine the minimum time between meter contact closures.

$$\text{spg} \div \text{cpg} = \text{available dose time in seconds}$$

PCM and Pump Sizing continued

II. Calculating Dosage Required (gpd)

1. The daily dosage requirements in gpd are based upon the maximum flow rate of the system, dosage requirements in ppm, and the strength of solution in ppm. **Refer to chart below.**
2. (max system flow rate X dosage required X 1440) ÷ solution strength

$$\text{(gpm X ppm X 1440)} \div \text{ppm} = \text{required dose output (gpd)}$$

Common Chemical Solution Strengths

Common Name	Chemical Name	Strength %	Strength ppm
Bleach	Sodium Hypochlorite (NaOCl)	5.25	52,500
Bleach	Sodium Hypochlorite (NaOCl)	6.125	61,250
Bleach	Sodium Hypochlorite (NaOCl)	12.5	125,000
Potassium Permanganate	Potassium Permanganate as KMnO ₄ dissolved at 1/4 lb per Gal	3	30,000
Peroxide	Hydrogen Peroxide	7	70,000
Polyphosphate	Polyphosphate dissolved at 1/4 lb per 10 Gals	1.2	12,000

US and Canada call 1-800-683-2378, other countries call 1-904-641-1666

PCM and Pump Sizing continued

Stenner Fixed Output Pumps

Model	gpd
45MPHP2	3
45MPHP10	10
45MPHP22	22
85MPHP5	5
85MPHP17	17
85MPHP40	40

III. Selecting a Feed Pump Model

Select a model number from the table that slightly exceeds the required dose output (gpd) as determined in Step II.

IV. Determining Feed Time Duration (seconds)

Divide the required dose output (gpd) as determined in Step II by the output of the model pump selected in Step III and multiply by the available dose time from Step I.

$$(\text{gpd required} \div \text{gpd selected pump}) \times \text{available dose time in seconds} = \text{feed time duration}$$



NOTICE: Use a PCM and pump model combination that prevents the PCM time setting (Step IV) from being greater than the **available dose time** (Step I). The **available dose time** is the minimum time duration between water meter contacts (or input signals to the PCM at maximum system flow rate). **DO NOT** adjust the PCM to a setting greater than the available dose time. Failure to maintain this relationship will result in chemical feed errors. The PCM is designed for use with fixed output metering pumps. Adjustable pumps **MUST** be used at maximum output.

PCM and Pump Sizing continued

V. Determining PCM Model and Setting

1. If feed time duration is:

- Less than 1 second, select PCM1.
- Between 1 and 5 seconds, select PCM5.
- Between 5 and 10 seconds, select PCM10.
- Between 10 and 20 seconds, select PCM20.

Model	Time Range (seconds)
PCM1	0.1 – 1.0
PCM5	0.5 – 5.0
PCM10	1.0 – 10.0
PCM20	2.0 – 20.0
Timing options are factory preset.	

2. To determine % setting of the PCM, divide feed time duration (Step IV) by max. seconds of PCM model selected and multiply by 100.

$$\text{feed time duration in seconds} \div \text{PCM model max seconds} \times 100 = \text{\% PCM setting}$$

This will give you the % setting of the PCM. The PCM has a 10:1 turndown ratio and the setting is achieved by turning the PCM knob to the approximate % setting.

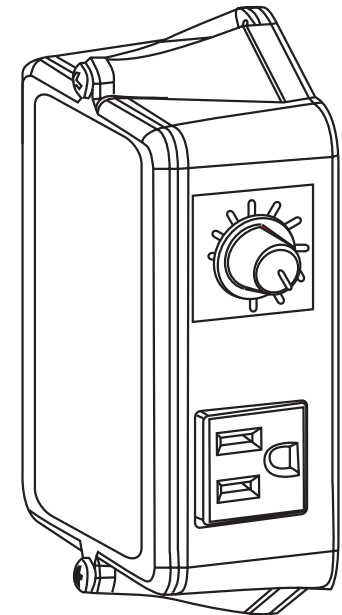

NOTICE: FINAL PCM SETTINGS must be determined through analytical testing of the water. The procedure and formulas contained herein are intended solely as a guide to be used to assist in the proper application of Stenner's PCM (Pump Control Module). Stenner Pump Company makes no guarantee as to the accuracy of the information contained herein. User assumes all risk and liability from use of the information contained in this manual.

Installation

 **Do not mount PCM in a dry location to avoid water intrusion and damage.**

1. Position the PCM within 6 feet of the Stenner fixed output metering pump and mount to a suitable surface using adequate fasteners through the mounting holes.

 **Do check supply voltage prior to connecting power cord to prevent damage. The use of a GFCI circuit is recommended.**

2. Uncoil the input signal cable and remove approximately 2 inches of the outer cable jacket.

 **Do not connect PCM input signal cord to any AC voltage supply.**

 **Do not connect PCM input signal cord to any hall effect, 4-20mA or voltage carrying signal source.**

3. Strip the ends of the two wires within the cable approximately one-half inch.

 **Do use PCM ONLY with a dry contact, reed switch style water meter.**

4. Attach the two wires to the contact output water meter or relay switch.
5. Adjust the knob to the desired on-time duration. Refer to the "PCM and Pump Sizing" on pages 7-11 for assistance.

 **Do not use pump adjustment to control dosage. An adjustable metering pump must be used at the maximum pump setting or use a fixed output pump.**

6. Plug the fixed output chemical feed pump power cord into the PCM's receptacle.
7. Plug the PCM power cord into a properly installed, grounded, 120VAC receptacle.

Installation Diagram

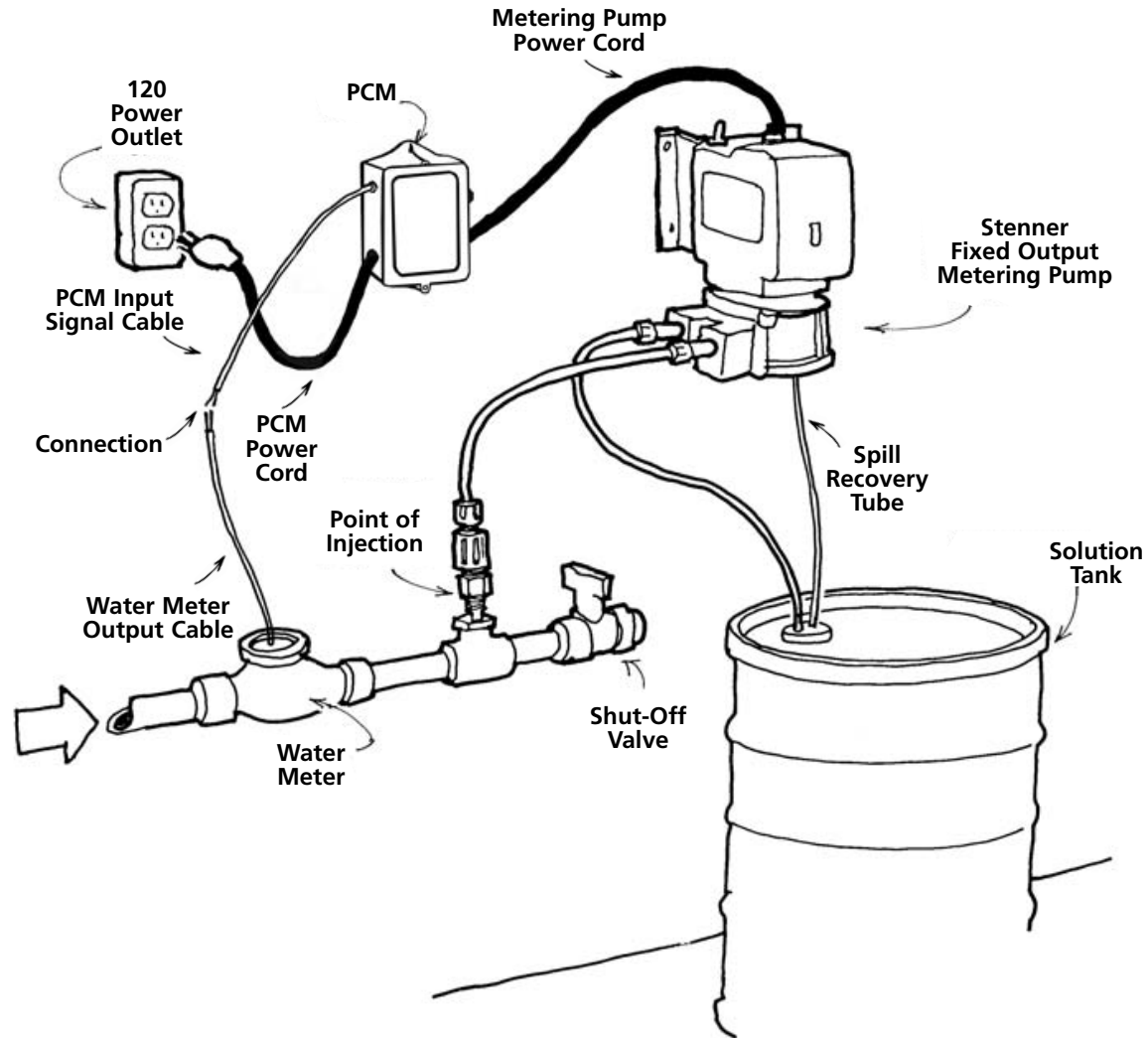

US and Canada call 1-800-683-2378, other countries call 1-904-641-1666

Troubleshooting

The typical cause of an apparent failure of the PCM is usually:

Lack of Input Supply Voltage (120VAC)

Plug the fixed output chemical metering pump directly into the 120VAC receptacle into which the PCM was originally plugged; this will bypass the PCM. If the pump does not run, the power source or pump is defective. If the metering pump operates, proceed to "Lack of Proper Input Signal".

Lack of Proper Input Signal

Plug the metering pump into the PCM and the PCM into the receptacle tested in Step I. Remove the PCM input signal cable from the water meter or relay and touch the two wires together. The pump should run for the pre-determined on-time and then stop.

- If the metering pump runs, the failure is in the water meter contacts.
- If the metering pump does not run, the failure is in the PCM.
- Contact the factory for information on service and repair.

PCM Model Conversion

 **WARNING** HAZARDOUS VOLTAGE: DISCONNECT power cord before removing motor cover for service.



The PCM time range is factory set according to the specific model. The time range can be changed to convert a PCM to any of four available time ranges without purchasing another model.

The time range is converted by changing the position of the jumper on the printed circuit board located under the PCM's cover. **Illustration A.** The PCM is equipped with two jumpers that are positioned over the pins labeled 3, 2, 1. **Illustration B.**

To change the time range:

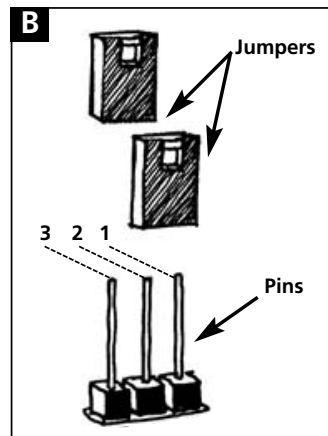
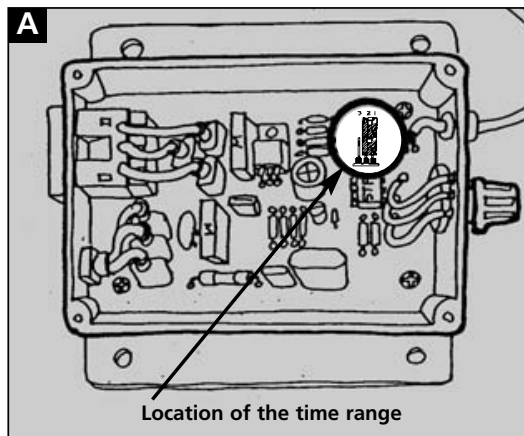
1. Unplug the PCM power cord from the input power supply.
2. Remove the cover (four screws) and reposition the jumper to correspond with the desired time range. **See chart below.**
3. Replace the PCM cover and secure with the four screws.
4. **IMPORTANT!** Update the PCM data label to represent the converted model and time range for accurate sizing.

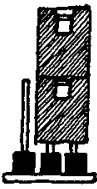

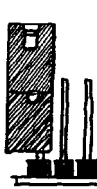
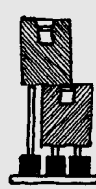
Model	PCM1	PCM5	PCM10	PCM20
Time Range	0.1 – 1.0 seconds	0.5 – 5.0 seconds	1.0 – 10.0 seconds	2.0 – 20.0 seconds
Jumper	2 & 1 	3 & 2 	3 	3 & 2, 2 & 1 



STENNER

Metering Pumps
Manufactured Since 1957

**3174 DeSalvo Road
Jacksonville, Florida 32246
sales@stenner.com
www.stenner.com**

Phone: 904.641.1666
US Toll Free: 800.683.2378
Fax: 904.642.1012

Hours of Operation (EST):
Mon. – Fri. 7:00 am – 5:30 pm